



BIGSPOT 600



USER MANUAL



BIGSPOT 600

Table of contents

1. Safety Instructions	3/6
2. Technical Specification	7/10
3. Fixture Dimensions	11
4. Photometry	12
5. Menu.....	13/16
6. Controlling The Fixture	17
7. DMX Channels	18/26
8. Trouble Shooting	27/29
9. Fixture Cleaning	30

Statement

Thank you for choosing our LED lights. Each fixture has been rigorously tested. Please check whether the fixture has been damaged during transportation. If you find any parts are missing or broken, please contact the manufacturer immediately. Please do not return the product without any notice!



1.Safety Instructions

You now own a professional lighting unit that offers endless possibilities. Before installing, make sure that no damage was done to your luminaire during transport.

For your own safety and that of others, please read this instruction manual carefully before installing the unit.

Anyone involved in installing, operating or servicing the 600W LED profile fixture must:

- Be a qualified, authorized professional
- Strictly follow the instructions in this user manual.

Please take the time to read this manual carefully and thoroughly before installing and operating the 600W LED profile fixture. You should have a good knowledge of its operating conditions and all pertinent product information.

After you have become familiar with this manual, we recommend that you keep a copy for future use. All the information found in this manual is subject to change without notice.

SAFETY INSTRUCTIONS

Please read the safety instructions and warnings in this manual carefully before installing and operating the 600W LED profile fixture .

WARNING!

The 600W LED profile fixture left our factory in perfect working condition. However, if you notice a defect, immediately contact your authorized 600W LED profile fixture dealer before use.

The manufacturer cannot be held responsible for damages caused by a failure to follow the safety, Installation or assembly instructions contained herein, or by any modification made to the fixture .

Failure to observe the safety, installation or assembly instructions contained herein, or any modification made to the 600W LED profile fixture will render the warranty null and void.

Check that the supply voltage does not exceed the maximum authorized limit. Check that your electrical installation complies with current standards.

In all cases, make sure that the power cables attached to your 600W LED profile fixture have not been damaged due to cuts and splices or crushed in any way.

Handle these cables with extreme caution while they are connected to a power source.



Your 600W LED profile fixture conforms to Class 1 safety standards. The unit must be grounded electrically. Make sure that the power source connected to your fixture is switched off before attempting any work on it.

Installation and connection to an electrical source must be performed by an authorized installer. Our factory declines all responsibility should this fixture be installed by an unqualified person.

Never disconnect your fixture by pulling on the power cable! First unlock the connector lock ring on the power cable until it is fully disengaged, and then gently pull on the connector to disconnect the cable.

Do not connect or disconnect the power cable of your 600W LED profile fixture with wet hands.

At first use, your fixture may give off an odor. This is a normal occurrence that should dissipate after a few minutes of operation.

Be careful to power off your 600W LED profile fixture by removing the power plug from the source, before connecting or disconnecting the 600W LED profile fixture .

Never look directly into the lamps if lit or stand directly in line with the fixture if close by.

Installation, removal or replacement of the unit must be performed with power off to prevent any risk of glare and eye injury.

To avoid risk of burn, never handle or adjust the fixture while it is energized and after it has been lit for more than 10 consecutive minutes. Some parts of the fixture can reach a high temperature, particularly the body/radiator. Turn off the fixture and wait for it to cool before handling.

CONDITIONS OF USE

Your 600W LED profile fixture is a moving-head luminaire equipped with LED source intended for professional use (e.g., architectural, stage, television, theater, or museum lighting).

The 600W LED profile fixture has an IP20 protection rating. It is intended strictly for indoor use. It must never be partially or fully submerged, even temporarily.

Condensation may form on your 600W LED profile fixture in the following cases:

- Immediately after turning on the heating
- In places with fog or a high level of humidity
- When the luminaire is suddenly moved from a cold to a warm environment, or vice versa.



In such cases, you must wait until the luminaire readjusts to the ambient temperature of the room where it will be installed for operation.

Do not shake the 600W LED profile fixture while installing or handling.

Do not pull the fixture by one of its cables to move it. Lift the fixture by its handles.

Choosing the appropriate place to install the 600W LED profile fixture is essential. The following points should be observed:

- Do not expose it to a heat source.
- Do not install it near flammable materials.
- Be sure that dust or miscellaneous debris cannot clump around the body of the luminaire as this may interfere with its optimal cooling and proper operation.
- The 600W LED profile fixture must be installed out of reach of the public and all persons not authorized to operate the luminaire.

We recommend a minimum distance of 5 m between the outside surface of the light and the illuminated object.

Due to the nature of its cooling principle, you should never prevent air from circulating around the body of the fixture. You must provide a minimum clearance around your fixture to allow for cooling.

The fixture can be installed in a ground pit or any other confined enclosure only under certain conditions. With this kind of installation, a system of forced ventilation should be used up to allow air to circulate freely around the fixture. The air must be constantly renewed because the luminaire cannot be operated in closed system. Failure to comply with these requirements may destroy or prematurely wear the fixture, and manufacturer cannot be held responsible. Please consult your fixture dealer for more information on this type of installation.

No load should be placed on the fixture. The fixture must not be installed in such a way as to allow a person, vehicle or any object to run over or park on it.

Never lay or drop any hard, heavy, or blunt, objects on the fixture. This includes items made of glass or porcelain (e.g., bottles, dishware, or glass beads). The fixture is made of materials such as plastic and extruded aluminum, making it resistant but not unbreakable. Objects made of hard materials such as steel or glass that fall on the unit may cause breakage of the plastic parts or the body. Manufacturer cannot be held responsible for the fixture's broken plastic parts or body, which are not covered under warranty.

The temperature of the room where the fixture is installed must never exceed 45°C (Ta = 45°C).



The fixture requires a 110-240 VAC supply voltage. Check that your fixture have been installed for an application that is compatible with this information.

Check that the brackets on which you hang or attach your fixture can sustain the weight of the 600W LED profile fixture (30kg), taking into consideration all necessary safety factors.

Do not use your 600W LED profile fixture before being familiar with these recommendations and do not allow unqualified personnel to handle the product.

To transport your fixture, we strongly recommend that you use the complete original packaging, including the dense protective foam inserts.

If your 600W LED profile fixture is not being used for a long period, you should disconnect the 600W LED profile fixture from the power source.

Never dispose of the 600W LED profile fixture in a rubbish bin. Ensure that it is recycled. Please consult the current legislation in your country on recycling electronic equipment.

PRESENTATION AND FEATURES

600W LED profile fixture is a non-waterproof moving head wash light (IP20 protection rating) using the latest generation of high-performance of LED-type lamps.

This 600W LED profile fixture can be controlled remotely by an external DMX512 signal. The 600W LED profile fixture incorporates high power white LED source.

The 600W LED profile fixture requires from 34 to 54 DMX channels to be controlled via an external command system that sends a DMX512 signal (see below for details).

To adjust the settings on the fixture (i.e., DMX address, DMX operating mode and other options), a Remote Device Management (RDM)-type DMX controller may be required. The DMX RDM protocol is a universal, widely used standard.

There are a multitude of RDM DMX controllers on the market from different manufacturers . It is worth noting that an RDM DMX controller is not required to change the settings on the fixture.

A light console or any standard DMX-type controller is sufficient.

The 600W LED profile fixture consists of a metal frame and plastic covers. The power connectors and DMX512 signal connectors are on the back of the fixture's base.



2. Technical Specification

Optics

Light source: 600W White LED

CT: 6500K

Life: 20,000H

CRI:>74 or >90

Power

Max power consumption: 850W Pf:>0.98

Power supply: Electronic auto-ranging

Input voltage range: 100-240V, 50-60HZ

Connectors

DMX and RDM data in/out: Locking 3-pin & 5-pinXLR

ArtNET Port: Rj45

Movement

Pan movement: 540°/ 630°(16 bit)

Tilt movement: 270°(16 bit)

Advanced motion system: auto repositioning, fast, quiet and smooth

Colours

CMY colour Mixing

CTO linear

CT: 2700K-6500K

Colour wheel: 6 dichroic filters + open

The colour wheel can be seamlessly rotating at different speeds.

This enables intermediate colour to be realized and rainbow to be achieved

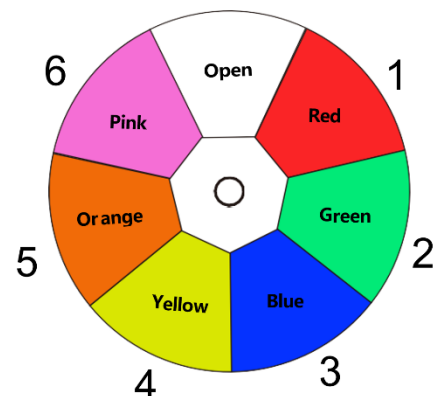

CMY+CTO(2700K-6500K)



The CMY colour mixing system expands the colour spectrum to an almost unlimited number of colours and enables smooth colour progressions and transitions

Gobos

1 Rotating gobo wheel:

6 rotatable, positioned, interchangeable gobos plus open with gobo shaking effect

Inside diameter:25mm Outside diameter:27.9mm

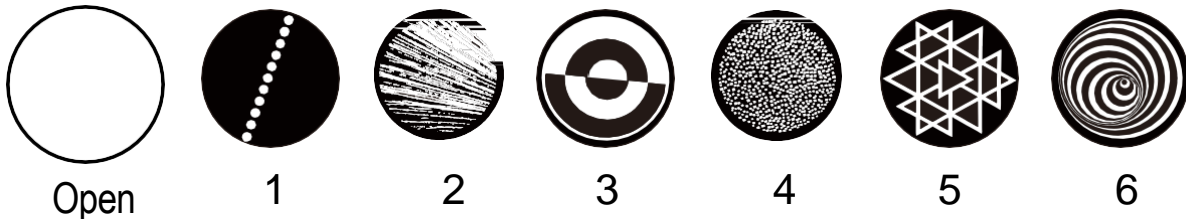
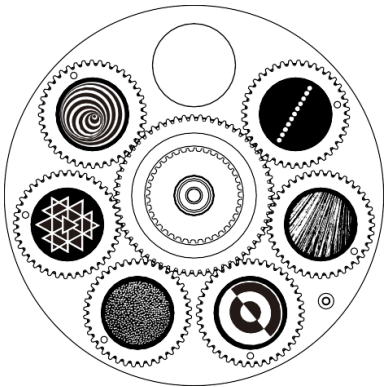

Static gobo wheel:

8 static , interchangeable gobos plus open with gobo shaking effect.

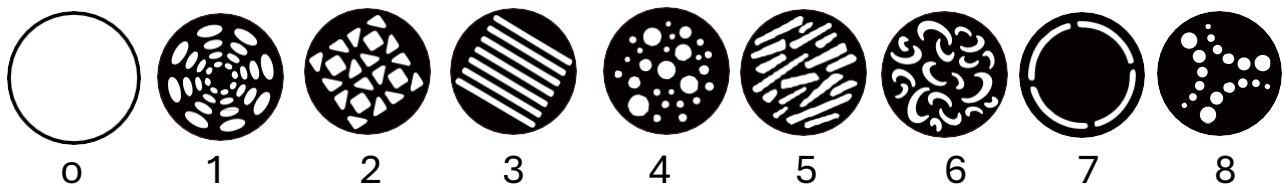
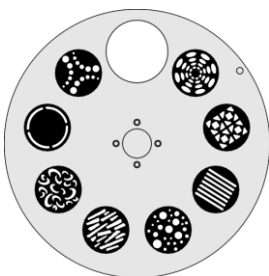

Animation wheel:

special dynamic flame or water effect, etc
Dynamic effects wheel is with continuous rotating in both direction, generating the realistic fire or water effects.

The continuous dynamic effects wheel can be used in combination with the two gobo wheels to create unique graphic effects.

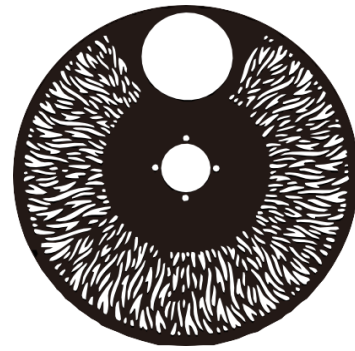
**Feature**

Prism: 5-facet prism rotating in both directions at variable speeds

Focus: motorized focus

Shutter: electronic, variable from 1-25Hz or random

Iris: 5-100% electronic Iris

Dimming: 0-100% linear adjustment

Frost: heavy frost

Zoom: 7°-45° linear zoom

Framing System

4 fast and smooth framing shutters,

Each shutter blade position and angle can be controlled individually

Movement is fast & smooth, with adjustable speed

Framing shutters can be precise motion with smooth movement

Each shutter blade can block out light completely

The framing module can be rotated at +/- 45°

Display

15 seconds standby auto lock

Pan/Tilt disengage (hold MENU and ENTER button)

Cooling System

Advanced liquid cooling system

Self-adjusting variable speed fans

Selectable ventilation user modes

Excess-temperature protection



Work Environment

Maximum ambient temperature: 40°C

Maximum surface temperature: 65°C

Maximum operating temperature: 0°C

Software

Remote reset DMX address, fixture reset

Run time of LED engine and fixture

2 control channel modes: 34 / 54 channels

Other specification

Input signal isolation

Optional ArtNET control

RDM compatible

Dimensions and weight

Net Weight:30kg / 66lbs

Gross weight: 35kg / 77lbs

Body size: 290 x 390 x 740 / 11.4" x 15.3" x 29"

Packing size: 830 x 450 x 370 / 32.6" x 17.7" x 14.5"



3. Fixture Dimensions

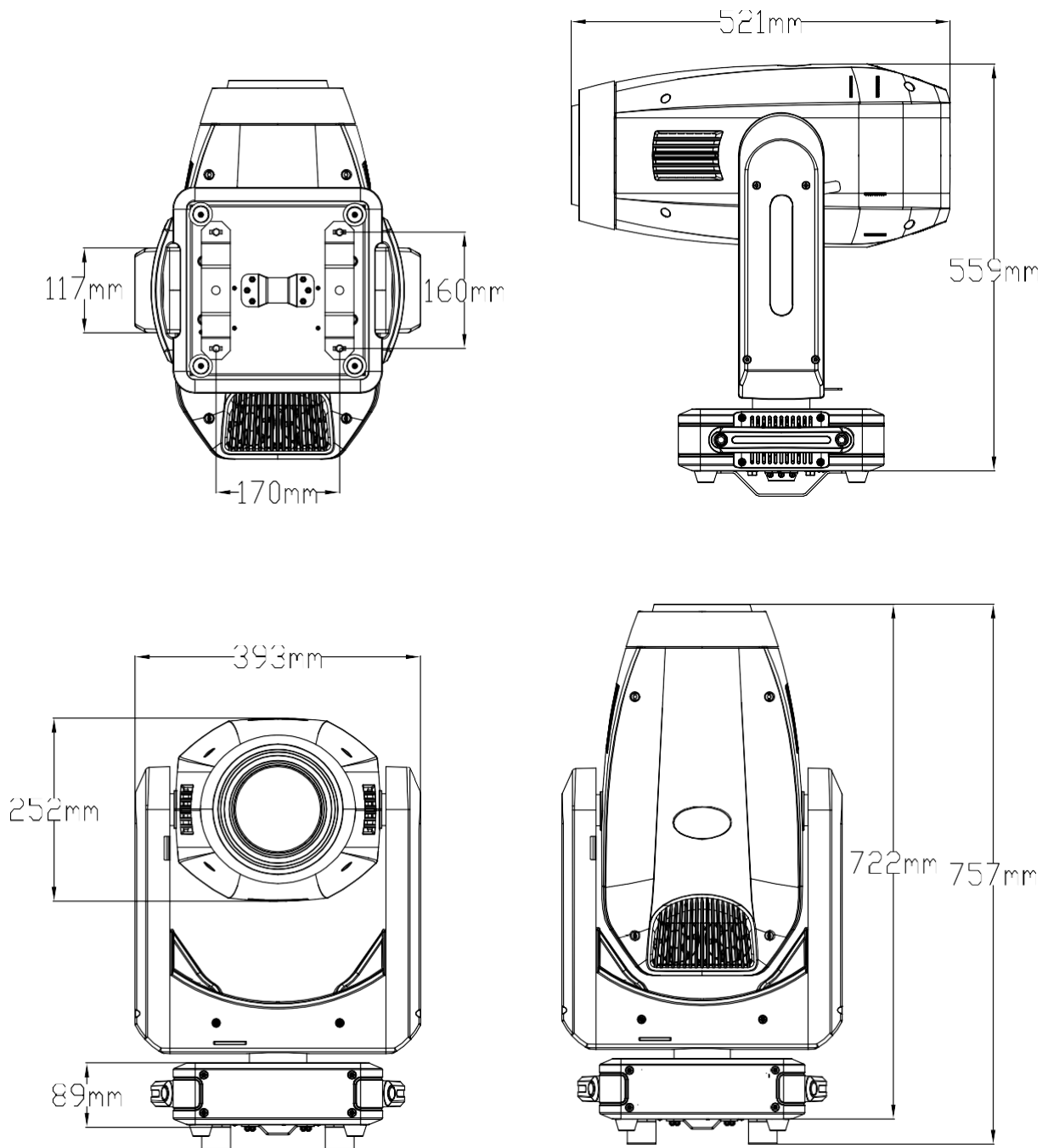

4. Photometry

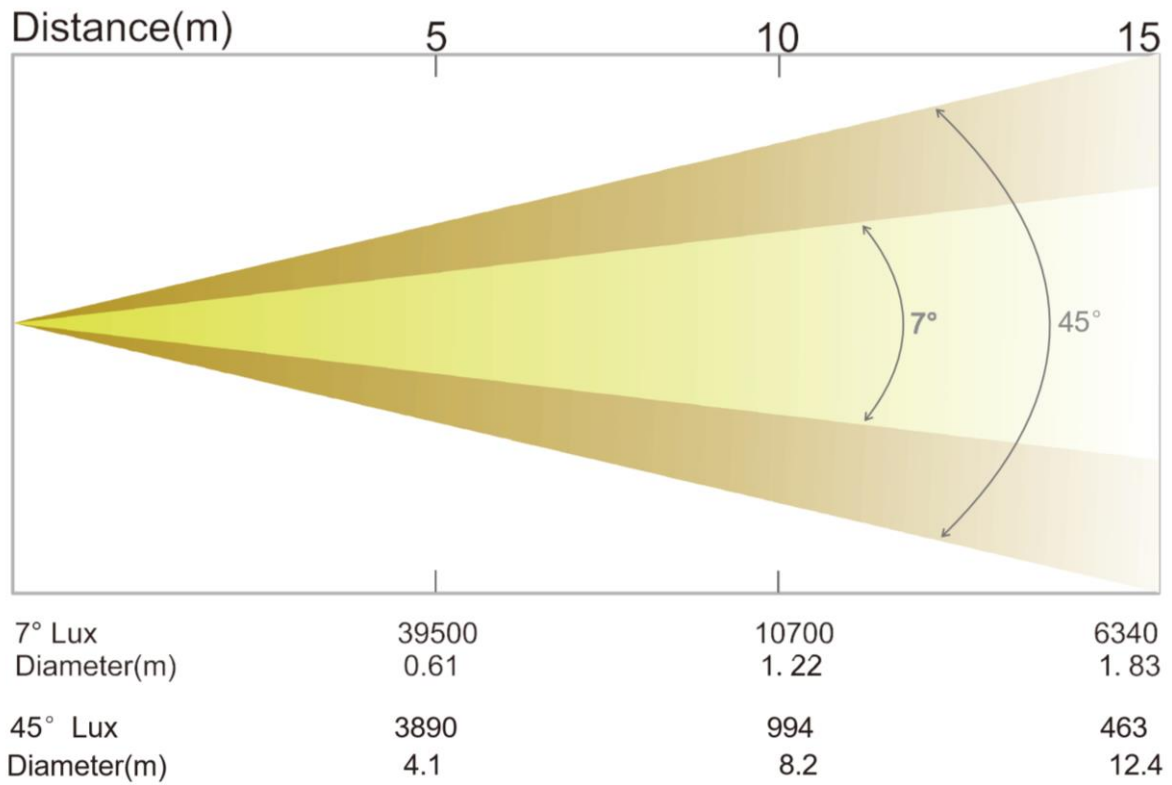

5. Menu

Display: To show the various menus and the selected function.

Button:

Enter	To perform the desired functions
DOWN	To go to move down in the menu
MENU	To enter into move backward or leave the menu
UP	To go backward or move up in the menu

How To Set The Unit Main Function

Turn on the unit, press the MENU button into menu mode, and press the UP/DOWN button until the required function is shown on the monitor, select the function by the ENTER button, Use the UP/DOWN button to choose the SUB-Menu, press the ENTER button to store and automatically return to the last menu. Press the MENU button or let the unit idle one minute to exit menu mode.

The main functions are shown below:



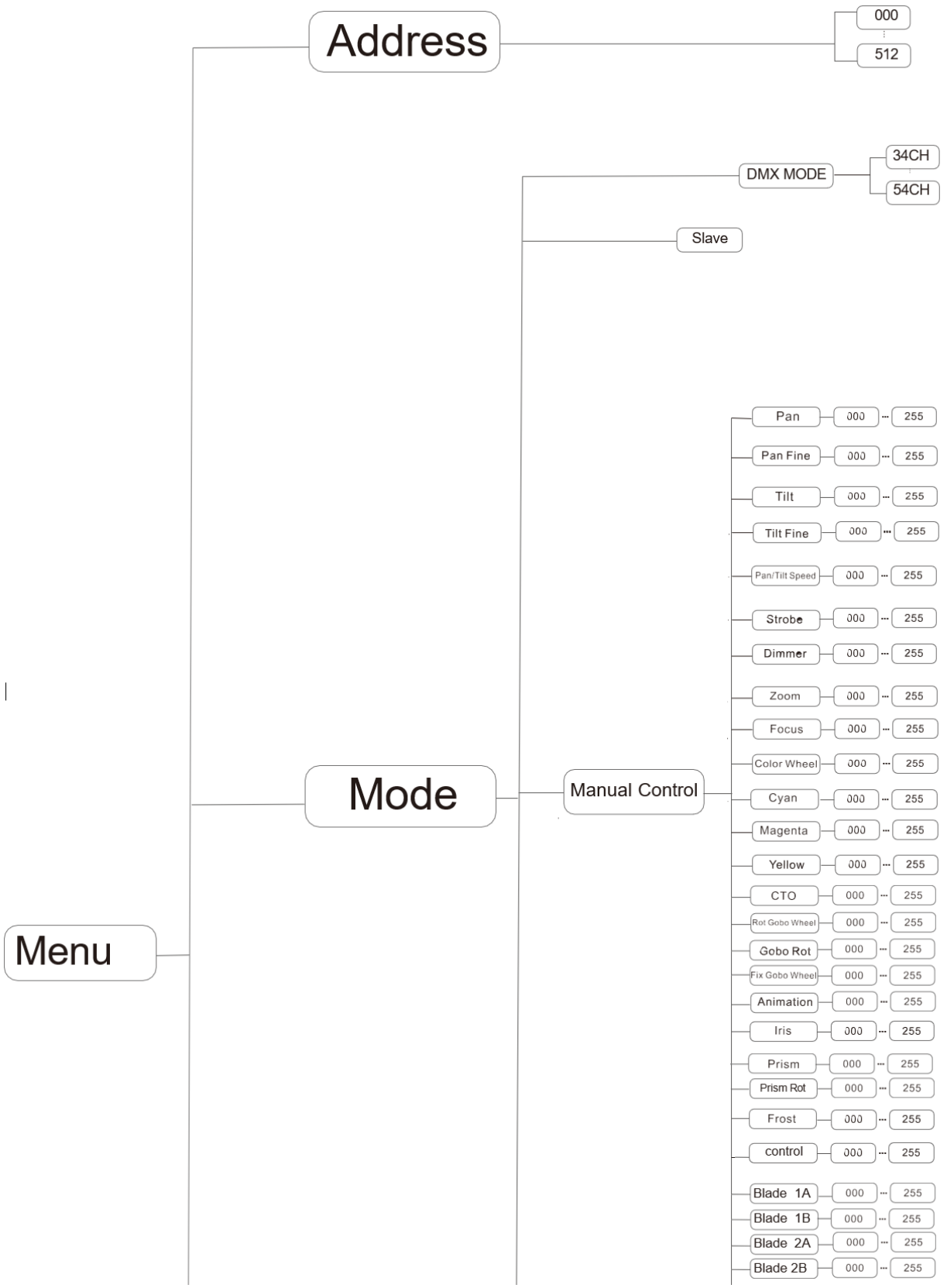

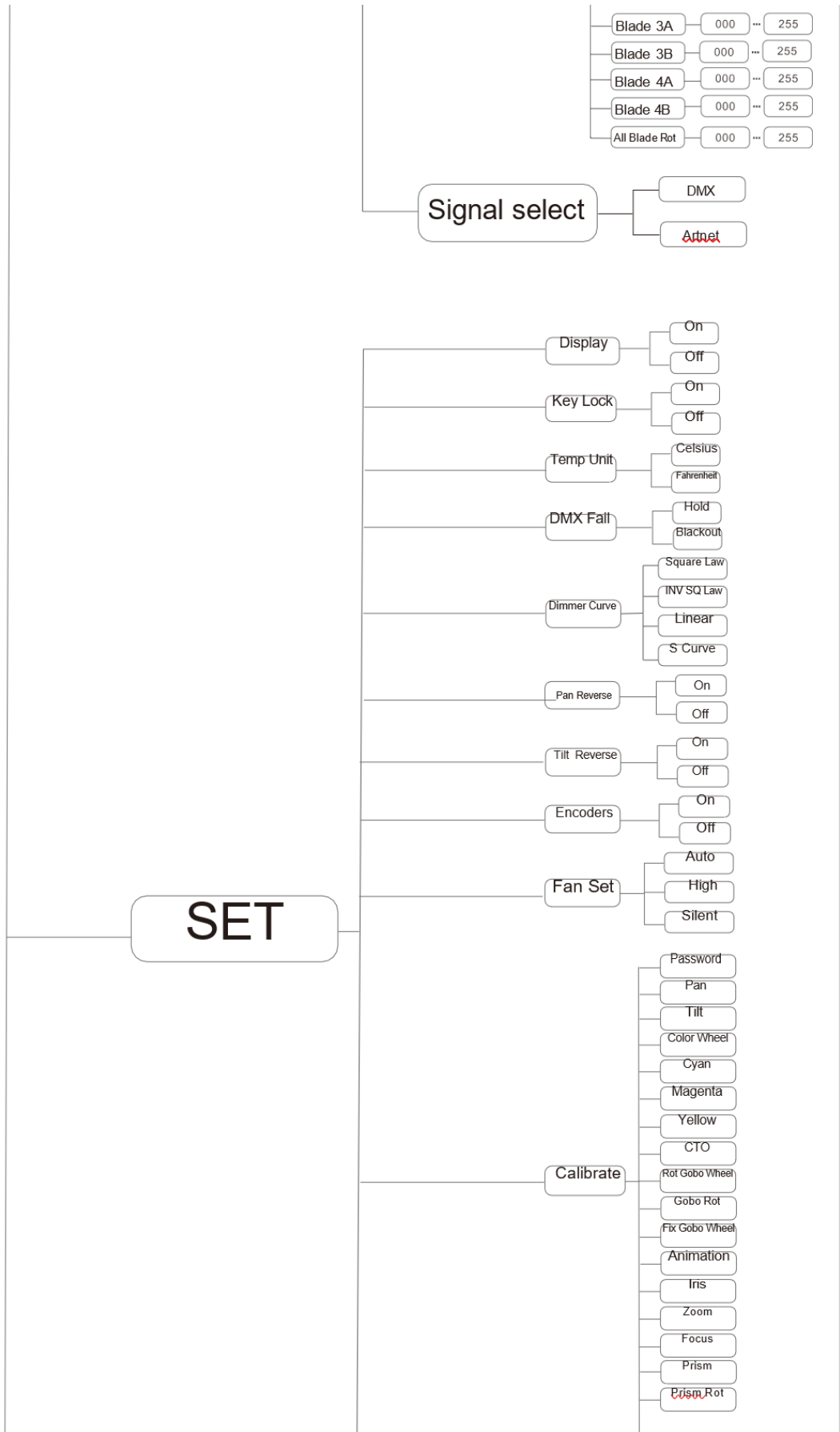

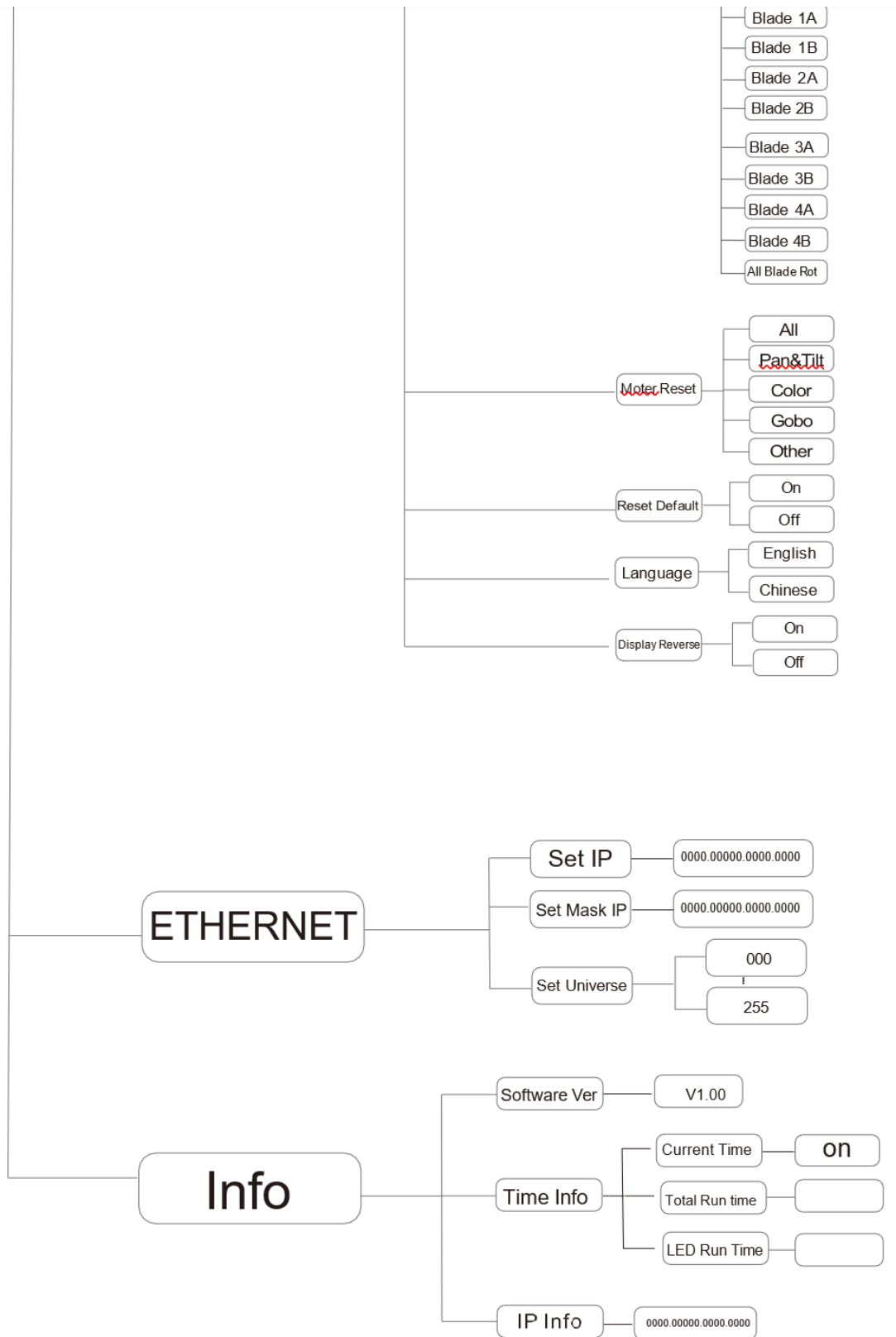

6. Controlling The Fixture

DMX512 CONNECTION

Connect the DMX input (XLR connector) cable of the luminaire to the DMX output (female XLR connector) of your controller. You can connect multiple 600W LED profile fixtures to this same DMX line in a daisy chain. The DMX cable must be a shielded twisted pair that is equipped with male and female XLR connectors.

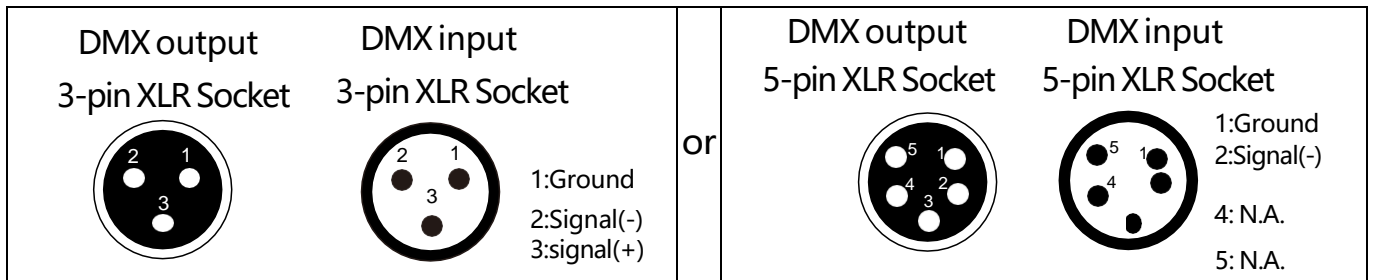

THE 600W LED profile fixture DMX ADDRESS SETTING

All fixtures must have a DMX start address correctly set when using a DMX signal to control them. The DMX start address is the channel from which the fixture “listens” to the digital control information sent by the DMX controller.

The start address must conform to the one set on the DMX controller to control the fixture. This address is the DMX value that appears on the fixture’s display. You can set the same address for all the fixtures, or some of them, but you can also set a different address for each fixture, as needed.

If you do set the same address for all the fixtures, they will all “listen” from the DMX channel you have set. The instructions sent by the DMX controller will affect all fixtures at the same time. If you set a different address per fixture, the DMX controller can control each independently. If, for instance, the fixtures are preset in 00-channel DMX mode (required for full control), you will need to adjust the DMX address for the luminaires as follows: The first unit with DMX address 001, the second with DMX address 035 (34 + 1), the third with DMX address 069 (035+34), etc.



7. DMX Channels

DMX 512 Configuration

Please refer to below configurations to control the fixtures Attentions:

- 1.The unit will maintain the last condition until reset if you cut-off the DMX signal.
- 2.For the channel Function, keep the value for about 5 seconds, then the corresponding function will take into effect.

Mode		Value	Function
34CH	54CH		
1	1		Pan Movement 8bit:
		0-255	Pan Movement
2	2		Pan Fine 16bit
		0-255	Fine control of Pan movement
3	3		Tilt Movement 8bit:
		0-255	Tilt Movement
4	4		Tilt Fine 16bit
		0-255	Fine control of Tilt movement
5	5		Speed Pan/Tilt movement:
		0-255	max to min speed
6	6		Shutter,stroke
		0-10	Shutter closed
		11-21	No function (shutter open)
		22-126	Strobe effect slow to fast
		127-137	No function (shutter open)
		138-201	pulse-effect in sequences
		202-212	No function (shutter open)
		213-244	Random strobe effect slow to fast
		245-255	No function (shutter open)
7	7		Dimmer intensity:
		0-255	Intensity 0 to 100%



	8		Dimmer intensity Fine:
		0-255	Dimmer intensity fine
8	9		Zoom:
		0-255	Zoom adjustment from small to big
	10		Zoom Fine:
		0-255	Zoom adjustment Fine
9	11		Focus:
		0-255	Continuous adjustment from near to far
	12		Focus Fine:
		0-255	Continuous adjustment Fine
10	13		Auto Focus:
		0-51	Auto Focus Off
		52-102	5m
		103-153	7m
		154-204	10m
		205-255	15m
11	14		Auto Focus Fine:
		0-255	Continuous adjustment Fine









12	15		Color Wheel:
		0-15	White
		16-23	White+Red
		24-31	Red
		32-39	Red+Green
		40-47	Green
		48-55	Green+Blue
		56-63	Blue
		64-71	Blue+Yellow
		72-79	Yellow
		80-87	Yellow+Orange
		88-95	Orange
		96-103	Orange+Pink
		104-111	Pink
		112-119	Pink+White
		120-127	White
		128-189	Forwards rainbow effect from fast to slow
		190-193	No rotation
194-255	Backwards rainbow effect from slow to fast		

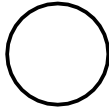



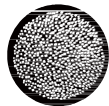





	16		Color Wheel Fine:
		0-255	Color Wheel colour change to any position Fine
13	17		Cyan Color:
		0-255	Cyan (0-white,255-100% Cyan)
	18		Cyan Color Fine:
		0-255	Cyan Fine
14	19		Magenta Color:
		0-255	Magenta (0-white,255-100% Magenta)
	20		Magenta Color Fine:
		0-255	Magenta Fine
15	21		Yellow Color:
		0-255	Yellow (0-white,255-100% Yellow)
	22		Yellow Color Fine:
		0-255	Yellow Fine
16	23		CTO Color:
		0-255	CTO (0-white,255-100% CTO)
	24		CTO Color Fine:
		0-255	CTO Fine



17	25	Rotating gobos,cont.rotation 1:	
		0-21	Open 
		22-27	Rot.gobo1 
		28-41	Rot.gobo2 
		42-55	Rot.gobo3 
		56-69	Rot.gobo4 
		70-83	Rot.gobo5 
		84-97	Rot.gobo6 
		98-105	Open
		106-119	Gobo 1 shake slow to fast
		120-133	Gobo 2 shake slow to fast
		134-147	Gobo 3 shake slow to fast
		148-161	Gobo 4 shake slow to fast
		162-175	Gobo 5 shake slow to fast
		176-189	Gobo 6 shake slow to fast
		190-221	Gobo wheel rotation forwards from fast to slow
		222-223	No rotation
224-255	Gobo wheel rotation backwards from slow to fast		
18	26	Rotating gobo index,rotating gobo rotation 1:	
		0-127	Gobo indexing
		128-189	Forwards gobo rotation from fast to slow
		190-193	No rotation
		194-255	Backwards gobo rotation from slow to fast



	27		Rotating gobo indexing Fine 1:
		0-255	Fine indexing

19	28		Fixed Gobo2:
		0-13	Open 
		14-21	Gobo 1 
		22-32	Gobo 2 
		33-43	Gobo 3 
		44-54	Gobo 4 
		55-65	Gobo 5 
		66-76	Gobo 6 
		77-87	Gobo 7 
		88-101	Gobo 8 
		102-112	Gobo 1 shake slow to fast
		113-123	Gobo 2 shake slow to fast
		124-134	Gobo 3 shake slow to fast
		135-145	Gobo 4 shake slow to fast



		146-156	Gobo 5 shake slow to fast
		157-167	Gobo 6 shake slow to fast
		168-178	Gobo 7 shake slow to fast
		179-189	Gobo 8 shake slow to fast
		190-221	Gobo wheel rotation forwards from fast to slow
		222-223	No rotation
		224-255	Gobo wheel rotation backwards from slow to fast

			Animation wheel:
20	29	0-127	Animation indexing
		128-158	Forwards rotation from fast to slow
		159-162	No rotation
		163-193	Backwards rotation from slow to fast
		194-255	Backwards and forwards rotation from slow to fast
21	30		Iris:
		0-255	Max.diameter to Min.diameter
	31		Iris Fine:
		0-255	Iris Fine
22	32		Prism:
		0-127	Open
		128-255	Prism
23	33		Rotating prism index,rotating prism rotation
		0-127	Prism indexing
		128-189	Forwards prism rotation from fast to slow
		190-193	No rotation
		194-255	Backwards prism rotation from slow to fast
	34		Rotating prism indexing Fine:
		0-255	Fine indexing
24	35		Frost:
		0-127	Open
		128-255	Frost



25	36		Blade 1A:
		0-255	Open to Close
	37		Blade 1A Fine:
		0-255	Open to Close Fine
26	38		Blade 1B:
		0-255	Open to Close
	39		Blade 1B Fine:
		0-255	Open to Close Fine
27	40		Blade 2A:
		0-255	Open to Close
	41		Blade 2A Fine:
		0-255	Open to Close Fine
28	42		Blade 2B:
		0-255	Open to Close
	43		Blade 2B Fine:
		0-255	Open to Close Fine
29	44		Blade 3A:
		0-255	Open to Close
	45		Blade 3A Fine:
		0-255	Open to Close Fine
30	46		Blade 3B:
		0-255	Open to Close
	47		Blade 3B Fine:
		0-255	Open to Close Fine
31	48		Blade 4A:
		0-255	Open to Close
	49		Blade 4A Fine:
		0-255	Open to Close Fine
32	50		Blade 4B:
		0-255	Open to Close
	51		Blade 4B Fine:
		0-255	Open to Close Fine



33	52		All Blade Rotation:
		0-255	All Blade Rotation(45° To -45°)
	53		All Blade Rotation Fine:
		0-255	All Blade Rotation Fine
34	54		Reset, LCD, Fans
		0-9	unused
		10-19	Display Off
		20-29	Display On
		30-39	Display Invert Off
		40-49	Display Invert On
		50-59	Auto fan control mode
		60-69	High fan control mode
		70-79	Silent fan control mode
		80-89	Square Law
		90-99	Linear
		100-109	unused
		110-119	unused
		120-129	unused
		130-139	unused
		140-149	unused
		150-159	All motor reset
		160-169	Scan motor reset
		170-179	Colors motor reset
		180-189	Gobo motor reset
190-199	Other motor reset		
200-255	unused		



8. Trouble Shooting

ERROR MESSAGES

When you turn on the fixture, it will first perform an automatic reset. The display may show “Err channel is XX” indicating there is a problem with one or more of the channels. “XX”

represents channel 1, 2, 3, 4, 5 or 6, which contain the testing sensor for positioning. For example, the message, “Err channel is Pan movement”, indicates an error in channel 1. If there is an error on channel 1 and channel 3 at the same time, the following error message may appear:

“Err channel is Pan movement”, “Err channel is Tilt movement”. The system will flash twice, and the fixture will generate a second reset. If the error message persists after more than two resets, the channels showing errors will not work properly but the other channels will function normally.

Please contact your authorized dealer or manufacturer for service and do not attempt to repair the luminaire yourself.

PAN- movement Er

(PAN-yoke movement error): This message will appear after the reset if the yoke’s magnetic-indexing circuit malfunctions (failed sensor or magnet missing) or the stepping-motor is defective (also caused by its driving IC on the main PCB). The PAN- movement does not return to the default position after the reset.

TILT- movement Er

(TILT- head movement error) This message will appear after the reset of the fixture if the head’s magnetic-indexing circuit malfunctions ((Optical Sensor or Magnetic Sensor fails)) or the stepper motor is defective (or its driving IC on the main PCB). The TILT-movement is not located in the default position after the reset.

Zoom Er

(Zoom error) This message will appear after the reset of the fixture if the head’s magnetic-indexing circuit malfunctions (Optical Sensor or Magnetic Sensor fails) or the stepper motor is defective (or its driving IC on the main PCB). . The Zoom - movement is not located in the default position after the reset.



Focus Er

(Focuswheel error) This message will appear after the reset of the fixture if the head's magnetic-indexing circuit malfunctions (Optical Sensor or Magnetic Sensor fails) or the stepper motor is defective (or its driving IC on the main PCB).The Focus - movement is not located in the default position after the reset.

Color wheel Er

(Color wheel- error) This message will appear after the reset of the fixture if the head's magnetic-indexing circuit malfunctions (sensor failed or magnet missing) or the stepper motor is defective (or its driving IC on the main PCB).The Color - movement is not located in the default position after the reset.

Cyan Color Er

(Cyan Color wheel- error) This message will appear after the reset of the fixture if the head's magnetic-indexing circuit malfunctions (sensor failed or magnet missing) or the stepper motor is defective (or its driving IC on the main PCB).The CMY - movement is not located in the default position after the reset.

Magenta Color Er

(Magenta Color - error) This message will appear after the reset of the fixture if the head's magnetic-indexing circuit malfunctions (sensor failed or magnet missing) or the stepper motor is defective (or its driving IC on the main PCB).The CMY - movement is not located in the default position after the reset.

Yellow Color Er

(Yellow Color wheel- error) This message will appear after the reset of the fixture if the head's magnetic-indexing circuit malfunctions (sensor failed or magnet missing) or the stepper motor is defective (or its driving IC on the main PCB).The CMY - movement is not located in the default position after the reset.

CTO Er

CTOwheel- error) This message will appear after the reset of the fixture if the head's magnetic-indexing circuit malfunctions (sensor failed or magnet missing) or the stepper motor is defective (or its driving IC on the main PCB).The CTO -movement is not located in the default position after the reset.

Rot_Gobo wheel Er

(Rot_Gobo1wheel - error) This message will appear after the reset of the fixture if the head's magnetic-indexing circuit malfunctions (sensor failed or magnet missing) or the stepper motor is defective (or its driving IC on the main PCB).The Rot_Gobo1 - movement is not located in the default position after the reset.



Fix_Gobo wheel Er

(Fix_Gobowheel - error) This message will appear after the reset of the fixture if the head's magnetic-indexing circuit malfunctions (sensor failed or magnet missing) or the stepper motor is defective (or its driving IC on the main PCB). The Fix_Gobo - movement is not located in the default position after the reset.

Animation wheel Er

(Animationwheel - error) This message will appear after the reset of the fixture if the head's magnetic-indexing circuit malfunctions (sensor failed or magnet missing) or the stepper motor is defective (or its driving IC on the main PCB). The Animation - movement is not located in the default position after the reset.

Iris Er

(Iriswheel - error) This message will appear after the reset of the fixture if the head's magnetic-indexing circuit malfunctions (sensor failed or magnet missing) or the stepper motor is defective (or its driving IC on the main PCB). The Iris - movement is not located in the default position after the reset.

Prism Er

(Prism error) This message will appear after the reset of the fixture if the head's magnetic-indexing circuit malfunctions (sensor failed or magnet missing) or the stepper motor is defective (or its driving IC on the main PCB). The Prism_5 - movement is not located in the default position after the reset.

Frost Er

(Frost - error) This message will appear after the reset of the fixture if the head's magnetic-indexing circuit malfunctions (sensor failed or magnet missing) or the stepper motor is defective (or its driving IC on the main PCB). The Frost 1 - movement is not located in the default position after the reset.

Animation_Rot wheel Er

(Animation_Rotwheel - error) This message will appear after the reset of the fixture if the head's magnetic-indexing circuit malfunctions (sensor failed or magnet missing) or the stepper motor is defective (or its driving IC on the main PCB). The Animation_Rot - movement is not located in the default position after the reset.



9. Fixture Cleaning

The following points have to be considered during inspection:

- 1) All screws for installing the devices or parts of the device have to be tightly connected and must not be corroded.
- 2) There must not be any deformations to the housing , lenses, rigging and installation points (ceiling, suspension, trussing).
- 3) Motorized parts must not show any signs of wear and must move smoothly without issue.
- 4) The power supply cables must not show any damage, material fatigue or sediment.

Further instructions depending on the installation location and usage have to be adhered to by a qualified installer and any safety concerns have to be removed.

